



Wykeham Martin Furling Gear
Mast Bands
Davey Ash Blocks
Deck Leads
Shroud Plates
Gaff Span Shackles
Brass Track & Slides
Spinnaker Pole Fittings

Highfield Levers
Rigging Screws
Tufnol Type Blocks
Belaying Pins
Bowsprit Plates
Shackles & Thimbles
Snap Shackles
Parrel Beads



Rigging & Sail Handling

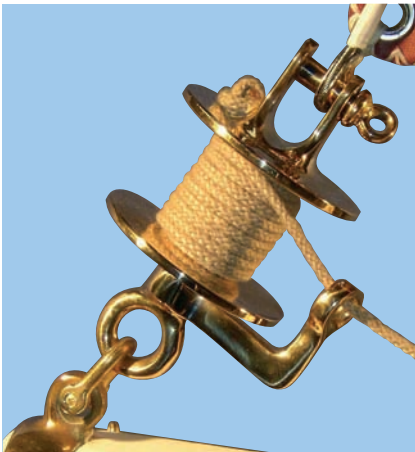

Wykeham Martin Furling Gear

In continuous production for around 100 years, this traditional furling gear has been successfully fitted to thousands of boats worldwide. Cast in bronze from the original patterns, the parts are carefully machined, polished and assembled by English craftsmen to produce a beautiful and efficient furling system. Fitted with stainless steel thrust races to ensure free running and easy sail furling. An information leaflet is available on request.

Dimensions in mm's

Top Swivel	Drum	Size	Approx. Sail Area		A	B	C	D	E
			sq. ft	sq. m					
9443/GM/01/TS	9443/GM/01/DR	1	50	5	72	10	eye	85	62
9443/GM/2B/TS	9443/GM/2B/DR	2B	100	10	100	18	11	128	85
9443/GM/3B/TS	9443/GM/3B/DR	3B	200	20	110	20	12	135	95
9443/GM/4B/TS	9443/GM/4B/DR	4B	350	35	150	28	16	165	150

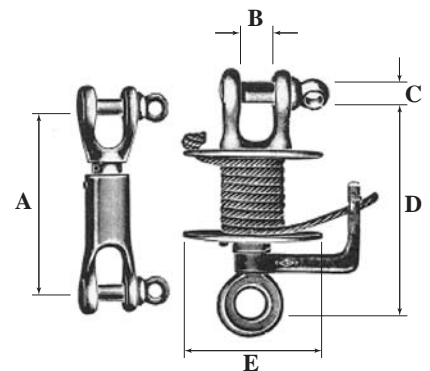

Highfields Pattern Running Backstay Lever

Gunmetal channel section, polished outside and pivoted with two side bolts leaving the channel clear for the wire to lie in. When the lever is down the wire is below the pivot point therefore the greater the stress, the more firmly the runner is locked. Quick release devise also available.

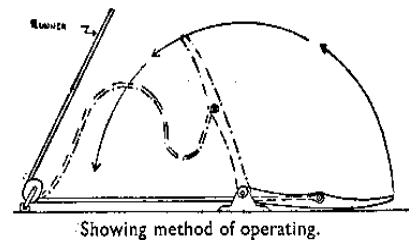

Lever	Size No	Wire	Lever Length		Base Size	
2655/GM/00	0	5mm	8"	200mm	3½" x 1⅜"	89 x 30mm
2655/GM/01	1	6mm	10"	250mm	3¾" x 1⅜"	95 x 35mm
2655/GM/02	2	8mm	16"	406mm	5" x 1¾"	125 x 46mm
2655/GM/03	3	10mm	23½"	597mm	7¼" x 2⅝"	196 x 67mm

Traditional Ash Mast Hoops

Traditional mast hoops made from ash and copper riveted, finished with 2 coats of linseed oil. Also available with stainless steel bolts so that the hoop can be fitted to a stepped mast. Other sizes also available.



NEW

Inside Diameter	Copper Riveted	Bolted
6"	0960/AH/150	0961/AH/150
7"	0960/AH/175	0961/AH/175
8"	0960/AH/200	0961/AH/200
9"	0960/AH/225	0961/AH/225
10"	0960/AH/250	0961/AH/250
12"	0960/AH/300	0961/AH/300



Mast Bands

Cast in gunmetal or galvanised iron, they are available with either two or four eyes.

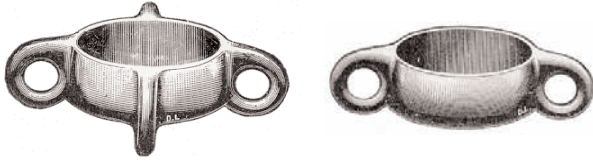

Gunmetal	Galvanised	No of Eyes	Internal dia.	
3416/GM/038	-	2	1½"	38mm
3416/GM/050	3416/GA/050	2	2"	50mm
3416/GM/062	3416/GA/062	2	2½"	62mm
3416/GM/075	3416/GA/075	2	3"	75mm
3416/GM/087	3416/GA/087	2	3½"	87mm
3416/GM/100	3416/GA/100	2	4"	100mm
3418/GM/050	3418/GA/050	4	2"	50mm
3418/GM/062	3418/GA/062	4	2½"	62mm
3418/GM/075	3418/GA/075	4	3"	75mm
3418/GM/087	3418/GA/087	4	3½"	87mm
3418/GM/100	3418/GA/100	4	4"	100mm

Sliding Gooseneck



This all brass dinghy fitting consists of a spike on a gooseneck with tangs and thumb screw for adjustment. Supplied with 12" (300mm) of brass internal track, size ⅝" (16mm).

Part No. 3401/BR

Halfband & Spike

Available in gunmetal or galvanised iron.

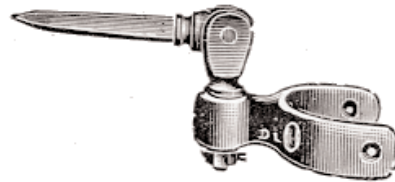

Gunmetal	Galvanised	Jaw width	
3402/GM/050	-	2"	50mm
3402/GM/062	3402/GA/062	2½"	62mm
3402/GM/075	3402/GA/075	3"	75mm
3402/GM/087	3402/GA/087	3½"	87mm

Tack



Clew



Boom Fittings

Tack and clew fittings cast in gunmetal. The clew fitting has a double swivel tang, and the tack has a square hole for use with roller reefing.

Part No	Description	Diameter	
9446/GM/T/050	Tack Boom End Fitting	2"	50mm
9446/GM/C/050	Clew Boom End Fitting	2"	50mm



Bronze Reefing Claw

Cast in aluminium bronze, which is a very tough alloy, this product is particularly suited to its purpose, being very stiff and strong yet without excessive bulk.

Part No	Inside Diameter	
9447/AB/100	4"	100 mm
9447/AB/125	5"	125 mm



Parrel Beads

Turned from Ash and treated with Linseed Oil.

Part No.	Length x Diameter		Bore
0924/00/022	⅞" x ⅞"	22 x 22mm	6mm
0924/00/035	1⅜" x 1⅜"	35 x 28mm	8mm
0924/00/044	1¾" x 1⅜"	44 x 35mm	10mm
0924/00/050	2" x 1⅜"	50 x 42mm	12mm
0924/00/070	2¾" x 2⅜"	70 x 55mm	18mm



Rigging & Sail Handling

Shroud and Bowsprit Plates

Manufactured in gunmetal and galvanised iron. To ensure correct positioning of the plates to the vessel, the gunmetal versions are now supplied undrilled, thus allowing the fitter to drill fixing holes that correspond to the boats strong points.



Gunmetal	Galvanised	Type	Length Overall	
9471/GM/075	–	Shroud plate	3"	75mm
9471/GM/100	9471/GA/100	Shroud plate	4"	100mm
9471/GM/150	9471/GA/150	Shroud plate	6"	150mm
9471/GM/200	9471/GA/200	Shroud plate	8"	200mm
9471/GM/250	9471/GA/250	Shroud plate	10"	250mm
9471/GM/300	9471/GA/300	Shroud plate	12"	300mm
9471/GM/400	9471/GA/400	Shroud plate	16"	400mm
9472/GM/100	9472/GA/100	Bowsprit plate	4"	100mm
9472/GM/150	9472/GA/150	Bowsprit plate	6"	150mm
9472/GM/200	9472/GA/200	Bowsprit plate	8"	200mm
9472/GM/250	9472/GA/250	Bowsprit plate	10"	250mm
9472/GM/300	9472/GA/300	Bowsprit plate	12"	300mm

Bronze Rigging Screws & Toggles

Manufactured from high tensile silicon aluminium bronze, the bodies are forged and the forks and toggles are machined from solid bar for extra strength. They are fitted with stainless steel clevis pins as standard, although bronze pins could be supplied at special request. These rigging screws and toggles exceed the breaking loads of modern high strength wire ropes and are equally suited to more traditional materials. Supplied in a polished bronze finish, this range has the strength and beauty to suit all types of fine craft.



Rigging Screw	UNF Thread	Wire Size	Length Fully Open		Length Fully Closed		Fork Width		Pin Dia.		Min. Break Load. kgs
1387/SA/06	1/4"	3-4mm	9"	228mm	5 7/8"	149mm	1/4"	6.3mm	1/4"	6.2mm	1447
1387/SA/08	5/16"	4-5mm	10 1/8"	258mm	6 3/4"	172mm	5/16"	8.0mm	5/16"	7.9mm	2343
1387/SA/10	3/8"	5-6mm	11"	280mm	7 3/8"	188mm	3/8"	9.5mm	3/8"	9.4mm	3597
1387/SA/11	7/16"	6-7mm	13"	330mm	9"	228mm	7/16"	11.2mm	7/16"	10.9mm	4853
1387/SA/12	1/2"	7-8mm	14"	355mm	9 3/4"	247mm	1/2"	12.7mm	1/2"	12.7mm	6599
1387/SA/16	5/8"	8-10mm	16 1/4"	414mm	11 3/8"	287mm	5/8"	16.0mm	5/8"	15.6mm	10631
1387/SA/19	3/4"	12mm	21 1/2"	548mm	14 1/4"	361mm	3/4"	19.1mm	3/4"	18.5mm	14467

All lengths are given as pin centre to pin centre.



Toggle	Size	Length	Fork Width		Pin Dia.	
1388/SA/06	1/4"	1 1/8"	1/4"	6.3mm	1/4"	6.2mm
1388/SA/08	5/16"	1 1/2"	5/16"	8.0mm	5/16"	7.9mm
1388/SA/10	3/8"	1 3/4"	3/8"	9.5mm	3/8"	9.4mm
1388/SA/11	7/16"	2 1/16"	7/16"	11.2mm	7/16"	10.9mm
1388/SA/12	1/2"	2 1/4"	1/2"	12.7mm	1/2"	12.7mm
1388/SA/16	5/8"	2 3/4"	5/8"	16.0mm	5/8"	15.6mm
1388/SA/19	3/4"	3 1/4"	3/4"	129.1mm	3/4"	18.5mm

All lengths are given as pin centre to hole centre.

Rigging & Sail Handling



Galvanised Rigging Screw

Closed body fork and fork rigging screw with lock nuts. Hot dipped galvanised.

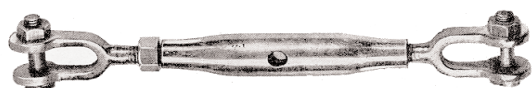

Galvanised	Thread Size	Length of Body
1371/GA/06/100	¼" 6mm	4" 100mm
1371/GA/08/112	⅜" 8mm	4½" 112mm
1371/GA/10/125	½" 10mm	5" 125mm
1371/GA/12/200	⅝" 12mm	8" 200mm
1371/GA/16/225	¾" 16mm	9" 225mm

Ships Pattern Rigging Screw

Galvanised tubular fork & eye rigging screw with metric threads. Shackle and thimble optional extras. Available tested and stamped with certificate to special order.



Galvanised	Thread Size	Body Length	Proof Load kgs
1370/GA/10/150	⅜" 10mm	6" 152mm	400
1370/GA/12/225	½" 12mm	9" 229mm	1000
1370/GA/16/225	⅝" 16mm	9" 229mm	1400
1370/GA/19/225	¾" 20mm	9" 229mm	2000

Larger sizes available to order.



Pelican Hook

Cast in gunmetal and polished. 4" (100mm) long overall. **Part No. 1390/GM**

Belaying Pins

Available in gunmetal, brass, galvanised iron and turned ash.



Gunmetal	Brass	Galvanised	O.A. Length	Stem Length	Stem Diameter
-	1634/BR/156	1634/GA/156	6¼" 158mm	3¾" 95mm	⅜" 10mm
-	1634/BR/187	1634/GA/187	7½" 190mm	4½" 114mm	½" 12mm
1634/GM/231	-	1634/GA/231	8¾" 222mm	5" 125mm	⅝" 16mm



Ash	O.A. Length	Stem Length	Stem Diameter
1636/AH/280/25	11" 280mm	6½" 165mm	⅝" 24mm
1636/AH/360/29	14½" 365mm	8¾" 223mm	1⅝" 29mm
1636/AH/500/32	20" 500mm	12" 305mm	1¼" 32mm

Galvanised Heart Thimbles



Galvanised	Rope Diameter	Galvanised	Rope Diameter
1190/GA/003	3	1190/GA/014	14
1190/GA/005	5	1190/GA/016	16
1190/GA/006	6	1190/GA/018	18
1190/GA/008	8	1190/GA/020	20
1190/GA/010	10	1190/GA/022	22
1190/GA/012	12	1190/GA/025	25

Galvanised Round Thimbles

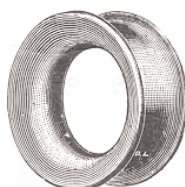

Galvanised	Outside Diameter	Inside Diameter	Score
1160/GA/039	1½" 39mm	1" 24mm	⅝" 14mm
1160/GA/045	1¾" 45mm	1⅜" 30mm	⅝" 15mm
1160/GA/050	2" 50mm	1⅞" 35mm	⅞" 17mm
1160/GA/065	2½" 64mm	1¾" 45mm	⅞" 22mm
1160/GA/080	3⅝" 80mm	2" 52mm	1" 25mm



Rigging & Sail Handling

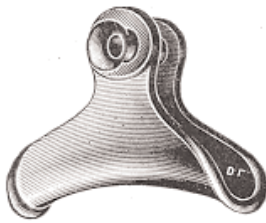

Gaff Span Shackles

Available in gunmetal and galvanised iron.

Gunmetal	Galvanised	Jaw Width		Pin Diameter		Length	
1227/GM/06	-	¼"	6mm	⅝"	8mm	2"	50mm
1227/GM/10	1227/GA/10	⅜"	10mm	⅜"	10mm	2½"	64mm
1227/GM/12	1227/GA/12	½"	12mm	⅞"	11mm	2⅞"	75mm
1227/GM/16	1227/GA/16	⅝"	16mm	½"	12mm	3⅝"	93mm



Stamped Brass Snap Shackles

Fixed Eye	Length	s.w.l. kg	Swivel with Lanyard Eye	Length	s.w.l. kg
3435/MB/031	1¼" 32mm	100	3439/MB/069	2¾" 69mm	250
3435/MB/041	1⅝" 41mm	150	3439/MB/081	3¼" 81mm	350
3435/MB/050	2" 50mm	250	3439/MB/100	4" 100mm	500
3435/MB/062	2½" 62mm	350	3439/MB/137	5½" 137mm	1000
3435/MB/075	3" 75mm	500	-	-	-
3435/MB/100	4" 100mm	1000	-	-	-

Manganese Bronze Shackles



Dee	Approx Break Strain	Harp	Approx Break Strain	Pin Dia	Shackle Dia.
1219/MB/03	400kg	-	-	3mm	3mm
1219/MB/04	500kg	-	-	4mm	4mm
1219/MB/05	600kg	1218/MB/05	400kg	5mm	5mm
1219/MB/06	1000kg	1218/MB/06	800kg	6mm	6mm
1219/MB/08	1600kg	1218/MB/08	1200kg	8mm	8mm
1219/MB/10	2400kg	1218/MB/10	1600kg	10mm	10mm

Galvanised Shackles - Standard Pattern

Shackle bow and pin are the same diameter.

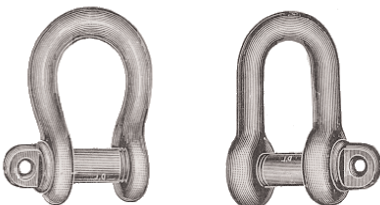

Dee	Harp	Bow Diameter		Pin Diameter	
1249/GA/005	1251/GA/005	⅜"	5mm	⅜"	5mm
1249/GA/006	1251/GA/006	¼"	6mm	¼"	6mm
1249/GA/008	1251/GA/008	⅝"	8mm	⅝"	8mm
1249/GA/010	1251/GA/010	⅜"	10mm	⅜"	10mm
1249/GA/011	1251/GA/011	⅞"	11mm	⅞"	11mm
1249/GA/012	1251/GA/012	½"	12mm	½"	12mm
1249/GA/016	1251/GA/016	⅝"	16mm	⅝"	16mm
1249/GA/019	1251/GA/019	¾"	19mm	¾"	19mm



Shackle Key

A lightweight anodised aluminium key to suit shackles up to ½".
Part No. 1189/AL



Track and Slides

Our track is extruded from brass and supplied in undrilled lengths of approx. 3 mtrs (10 foot). The slides are formed from brass sheet or cast in gunmetal and polished.

Internal Track and Slides

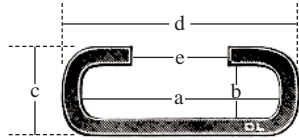

Brass	Nominal Size (a)	b	c	d	e
1321/BR/T/16	5/8"	16mm	3.25mm	8mm	21mm
1321/BR/T/19	3/4"	19mm	3.5mm	8mm	25mm
1321/BR/T/25	1"	25mm	5.5mm	12mm	31mm

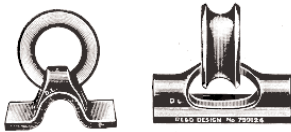

Brass	Size
1320/BR/S/16	5/8" 16mm
1320/BR/S/19	3/4" 19mm



Gunmetal	Size
1321/GM/S/19	3/4" 19mm
1321/GM/S/25	1" 25mm

External Track and Slides



Brass	Size
1296/BR/T/16	5/8" 16mm
1296/BR/T/19	3/4" 19mm



Brass	Size
1296/BR/S/16	5/8" 16mm
1296/BR/S/19	3/4" 19mm



Hatch Slides

Our 3/4" brass tracks, 1296/BR/T/19 and 1321/BR/T/19, mate perfectly together to provide secure, smooth running hatch sliding gear.

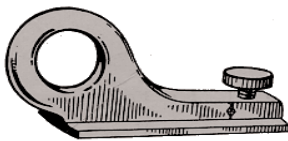

Sliding Decklead

Cast in gunmetal with a polished finish, this decklead fits the 1" (25mm) internal track. and has a knurled thumb screw to secure it at any point of its travel.

Part No. 3446/GM/025

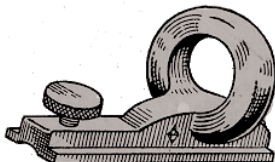

Spinnaker Pole Slide

Cast in gunmetal with a polished finish, this spinnaker pole slide fits the 1" (25mm) internal track. A knurled thumb screw locks it at the desired position.

Part No. 3443/GM/025

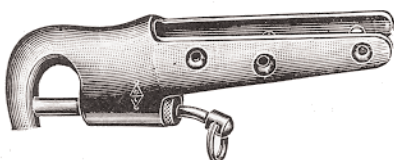

Spinnaker Pole End

Polished gunmetal end socket to fit to a wooden spar. Sprung piston end.

Gunmetal	Strap Length	Spar Diameter
3422/GM/100	4" 100mm	1 3/4" 45mm
3422/GM/125	5" 125mm	2 1/4" 58mm



Davey Ash Blocks

Inspired by our 1928 range, we have carefully developed these blocks to have the right proportions for the efficient use with ropes from 10mm to 14mm. They are strong, simple and functional but at the same time have the beauty and elegance to enhance the finest of craft.

Key Features

- Bindings: Heavy gauge stainless steel - internal. Fixed and swivel head.
- Sheaves: Tufnol type material as standard, aluminium bronze as an option.
- Bearings: Plain on oversized SS spindles to spread the load and ensure smooth running.
- Shell: High quality ash, formed into a smooth oval shape and varnished.
- Maintenance: By removing just one machine screw the block can easily be disassembled for inspection and maintenance without damaging the wooden shell.
- Appearance: Just beautiful!



Single Block				
	Shell Length	Rope Size mm	Sheave size mm	SWL Kg
0610/AH/075	3" 75mm	8 - 10	40	1500
0610/AH/088	3 1/2" 88mm	10 - 12	50	1750
0610/AH/100	4" 100mm	12 - 14	60	2000

Single Block & Becket				
	Shell Length	Rope Size mm	Sheave size mm	SWL Kg
0611/AH/075	3" 75mm	8 - 10	40	1500
0611/AH/088	3 1/2" 88mm	10 - 12	50	1750
0611/AH/100	4" 100mm	12 - 14	60	2000

Double Block				
	Shell Length	Rope Size mm	Sheave size mm	SWL Kg
0612/AH/075	3" 75mm	8 - 10	40	1500
0612/AH/088	3 1/2" 88mm	10 - 12	50	1750
0612/AH/100	4" 100mm	12 - 14	60	2200

Double Block & Becket				
	Shell Length	Rope Size mm	Sheave size mm	SWL Kg
0613/AH/075	3" 75mm	8 - 10	40	1500
0613/AH/088	3 1/2" 88mm	10 - 12	50	1750
0613/AH/100	4" 100mm	12 - 14	60	2200

Fiddle Block				
	Shell Length	Rope Size mm	Sheave size mm	SWL Kg
0614/AH/175	7" 175mm	10 - 12	68 & 40	1750
0614/AH/206	8" 206mm	12 - 14	80 & 48	2000

Fiddle Block & Becket				
	Shell Length	Rope Size mm	Sheave size mm	SWL Kg
0615/AH/175	7" 175mm	10 - 12	68 & 40	1750
0615/AH/206	8" 206mm	12 - 14	80 & 48	2000



Single Block with Swivel					
	Shell Length		Rope Size mm	Sheave size mm	SWL Kg
0620/AH/075	3"	75mm	8 - 10	40	1500
0620/AH/088	3 1/2"	88mm	10 - 12	50	1750
0620/AH/100	4"	100mm	12 - 14	60	2000

NEW

Single Block with Swivel & Becket					
	Shell Length		Rope Size mm	Sheave size mm	SWL Kg
0621/AH/075	3"	75mm	8 - 10	40	1500
0621/AH/088	3 1/2"	88mm	10 - 12	50	1750
0621/AH/100	4"	100mm	12 - 14	60	2000

NEW

Double Block with Swivel					
	Shell Length		Rope Size mm	Sheave size mm	SWL Kg
0622/AH/075	3"	75mm	8 - 10	40	1750
0622/AH/088	3 1/2"	88mm	10 - 12	50	2000
0622/AH/100	4"	100mm	12 - 14	60	2200

NEW

Double Block with Swivel & Becket					
	Shell Length		Rope Size mm	Sheave size mm	SWL Kg
0623/AH/075	3"	75mm	8 - 10	40	1750
0623/AH/088	3 1/2"	88mm	10 - 12	50	2000
0623/AH/100	4"	100mm	12 - 14	60	2200

NEW

Single Block Stand-up					
	Shell Length		Rope Size mm	Sheave size mm	SWL Kg
0624/AH/075	3"	75mm	8 - 10	40	1500
0624/AH/088	3 1/2"	88mm	10 - 12	50	1750
0624/AH/100	4"	100mm	12 - 14	60	2000

NEW

Single Strop Block					
	Shell Length		Rope Size mm	Sheave size mm	SWL Kg
0617/AH/075	3"	75mm	8 - 10	40	575
0617/AH/088	3 1/2"	88mm	10 - 12	50	635
0617/AH/100	4"	100mm	12 - 14	60	700

Double Strop Block					
	Shell Length		Rope Size mm	Sheave size mm	SWL Kg
0618/AH/075	3"	75mm	8 - 10	40	635
0618/AH/088	3 1/2"	88mm	10 - 12	50	700
0618/AH/100	4"	100mm	12 - 14	60	800

Size Dia. x Width x Bore	Tufnol Type Sheave	Aluminium Bronze Sheave
40 x 12 x 10	0619/00/040	0619/AB/040
50 x 14 x 12	0619/00/050	0619/AB/050
60 x 16 x 12	0619/00/060	0619/AB/060

NEW



Rigging & Sail Handling

ALL NEW

Large Ash Blocks

Built to the same high standard, and similar construction method, as our smaller ash blocks but with larger ash shells in relation to the rope size, for use with larger craft. The high strength is derived from the heavy gauge stainless steel bindings and oversized spindles, on which the hard wearing ertalon sheaves run smoothly. The blocks are supplied varnished and suit ropes up to 26mm.



Single Block				
	Shell Length	Rope Size mm	Sheave size mm	SWL Kg
0650/AH/160	6 ⁵ / ₁₆ " 162mm	16 - 18	90	4600
0650/AH/200	7 ³ / ₄ " 197mm	20 - 22	112	6000
0650/AH/225	8 ³ / ₄ " 224mm	24 - 26	146	6750

Single Block & Becket				
	Shell Length	Rope Size mm	Sheave size mm	SWL Kg
0651/AH/160	6 ⁵ / ₁₆ " 162mm	16 - 18	90	4600
0651/AH/200	7 ³ / ₄ " 197mm	20 - 22	112	6000
0651/AH/225	8 ³ / ₄ " 224mm	24 - 26	146	6750



Double Block				
	Shell Length	Rope Size mm	Sheave size mm	SWL Kg
0652/AH/160	6 ⁵ / ₁₆ " 162mm	16 - 18	90	8850
0652/AH/200	7 ³ / ₄ " 197mm	20 - 22	112	12350
0652/AH/225	8 ³ / ₄ " 224mm	24 - 26	146	13500

Double Block & Becket				
	Shell Length	Rope Size mm	Sheave size mm	SWL Kg
0653/AH/160	6 ⁵ / ₁₆ " 162mm	16 - 18	90	8850
0653/AH/200	7 ³ / ₄ " 197mm	20 - 22	112	12350
0653/AH/225	8 ³ / ₄ " 224mm	24 - 26	146	13500



Triple Block				
	Shell Length	Rope Size mm	Sheave size mm	SWL Kg
0654/AH/160	6 ⁵ / ₁₆ " 162mm	16 - 18	90	8250
0654/AH/200	7 ³ / ₄ " 197mm	20 - 22	112	10750
0654/AH/225	8 ³ / ₄ " 224mm	24 - 26	146	13250

Triple Block & Becket				
	Shell Length	Rope Size mm	Sheave size mm	SWL Kg
0655/AH/160	6 ⁵ / ₁₆ " 162mm	16 - 18	90	8250
0655/AH/200	7 ³ / ₄ " 197mm	20 - 22	112	10750
0655/AH/225	8 ³ / ₄ " 224mm	24 - 26	146	13250

Also available to special order Snatch and Swivel Blocks for rope sizes 16-26mm.





Wooden Blocks with Roller Bearings

Manufactured in ash or teak with stainless steel bindings, these blocks have brass sheaves with roller bearings. Also available in larger sizes for ropes up to 20mm.

Single Block



Teak	Ash	Rope Size	Shell Length	Sheave Size	Breaking Load daN
0580/TK/060	0580/AH/060	10mm	60mm	30 x 12mm	1000
0580/TK/070	0580/AH/070	12mm	70mm	35 x 14mm	1300
0580/TK/080	0580/AH/080	14mm	80mm	40 x 16mm	2000
0580/TK/105	0580/AH/105	18mm	105mm	55 x 20mm	2200
0580/TK/120	0580/AH/120	20mm	120mm	65 x 22mm	2500

Single Block and Becket



Teak	Ash	Rope Size	Shell Length	Sheave Size	Breaking Load daN
0581/TK/060	0581/AH/060	10mm	60mm	30 x 12mm	1000
0581/TK/070	0581/AH/070	12mm	70mm	35 x 14mm	1300
0581/TK/080	0581/AH/080	14mm	80mm	40 x 16mm	2000

Double Block



Teak	Ash	Rope Size	Shell Length	Sheave Size	Breaking Load daN
0582/TK/060	0582/AH/060	10mm	60mm	30 x 12mm	1000
0582/TK/070	0582/AH/070	12mm	70mm	35 x 14mm	2000
0582/TK/080	0582/AH/080	14mm	80mm	40 x 16mm	2000

Double Block and Becket



Teak	Ash	Rope Size	Shell Length	Sheave Size	Breaking Load daN
0583/TK/060	0583/AH/060	10mm	60mm	30 x 12mm	1000
0583/TK/070	0583/AH/070	12mm	70mm	35 x 14mm	2000
0583/TK/080	0583/AH/080	14mm	80mm	40 x 16mm	2000

Bronze Blocks



Without Becket	With Becket	Rope Size	Sheave Diameter	Shell Length
0500/GM/037	-	6mm	7/8"	1 1/2" 38mm
0500/GM/050	0501/GM/050	8mm	1 1/4"	2" 50mm

Deckleads

A range of deckleads in three configurations to suit wire up to 6mm.

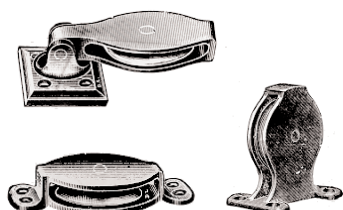

Gunmetal	Galvanised	Type	Sheave Size
9456/GM/050	9456/GA/050	Single Cheek	2" x 3/8"
9458/GM/050	9458/GA/050	Single Standup	
9460/GM/050	-	Swivel	50 x 10mm



Rigging & Sail Handling

Tufnol Type Plastic Laminated Blocks

These traditional laminated plastic blocks are both strong in use and competitively priced. They incorporate a strong AISI 304 stainless steel frame and brass bush bearings, and all breaking loads have been certified by Germanischer Lloyd in Hamburg. (1 daN equals approximately 1 kilo).

Larger blocks up to 22mm are also available to special order.

Single Block with Bow



Part No.	Rope Dia	Sheave Dia	Breaking Load daN	s.w.l. daN
4300/00/10	10mm	30mm	880	440
4300/00/12	12mm	35mm	1120	560
4300/00/14	14mm	50mm	2010	1005
4300/00/16	16mm	63mm	2210	1105

Single Block with Eye



Part No.	Rope Dia	Sheave Dia	Breaking Load daN	s.w.l. daN
4305/00/10	10mm	30mm	800	400
4305/00/12	12mm	35mm	1110	555
4305/00/14	14mm	50mm	2000	1000
4305/00/16	16mm	63mm	2190	1095

Single Block with Swivel



Part No.	Rope Dia	Sheave Dia	Breaking Load daN	s.w.l. daN
4310/00/10	10mm	30mm	810	405
4310/00/12	12mm	35mm	1110	555
4310/00/14	14mm	50mm	2050	1025
4310/00/16	16mm	63mm	2140	1070

Single Block with Bow and Becket



Part No.	Rope Dia	Sheave Dia	Breaking Load daN	s.w.l. daN
4315/00/10	10mm	30mm	820	410
4315/00/12	12mm	35mm	1250	625
4315/00/14	14mm	50mm	2210	1105
4315/00/16	16mm	63mm	2800	1400

Single Block with Eye and Becket



Part No.	Rope Dia	Sheave Dia	Breaking Load daN	s.w.l. daN
4320/00/10	10mm	30mm	820	410
4320/00/12	12mm	35mm	1250	625
4320/00/14	14mm	50mm	2210	1105
4320/00/16	16mm	63mm	2800	1400

Single Block with Swivel and Becket



Part No.	Rope Dia	Sheave Dia	Breaking Load daN	s.w.l. daN
4325/00/10	10mm	30mm	830	415
4325/00/12	12mm	35mm	1350	675
4325/00/14	14mm	50mm	2020	1010
4325/00/16	16mm	63mm	2200	1100



Double Block with Bow



Part No.	Rope Dia	Sheave Dia	Breaking Load daN	s.w.l. daN
4330/00/10	10mm	30mm	600	300
4330/00/12	12mm	35mm	900	450
4330/00/14	14mm	50mm	1720	860
4330/00/16	16mm	63mm	2000	1000

Double with Swivel



Part No.	Rope Dia	Sheave Dia	Breaking Load daN	s.w.l. daN
4335/00/10	10mm	30mm	630	315
4335/00/12	12mm	35mm	960	480
4335/00/14	14mm	50mm	1740	870
4335/00/16	16mm	63mm	2030	1015

Double Block with Bow and Becket



Part No.	Rope Dia	Sheave Dia	Breaking Load daN	s.w.l. daN
4340/00/10	10mm	30mm	610	305
4340/00/12	12mm	35mm	910	455
4340/00/14	14mm	50mm	1700	850
4340/00/16	16mm	63mm	2040	1020

Double Block with Swivel and Becket



Part No.	Rope Dia	Sheave Dia	Breaking Load daN	s.w.l. daN
4345/00/10	10mm	30mm	630	315
4345/00/12	12mm	35mm	970	485
4345/00/14	14mm	50mm	1710	855
4345/00/16	16mm	63mm	2010	1005
With Cam Cleat				
4370/00/16	16mm	63mm	2170	1085

Fiddle Blocks



Part No.	Rope Dia	Sheave Dia	Breaking Load daN	s.w.l. daN
With Bow				
4350/00/10	10mm	42mm & 20mm	760	380
4350/00/12	12mm	48mm & 25mm	1370	685
With Eye				
4355/00/10	10mm	42mm & 20mm	710	355
4355/00/12	12mm	48mm & 25mm	1200	600
With Swivel				
4360/00/10	10mm	42mm & 20mm	720	360
4360/00/12	12mm	48mm & 25mm	1200	600
With Swivel, Becket and Cam Cleat				
4365/00/10	10mm	42mm & 20mm	740	370
4365/00/12	12mm	48mm & 25mm	1210	605

Cheek Block



Part No.	Rope Dia	Sheave Dia	Breaking Load daN	s.w.l. daN
4395/00/10	10mm	30mm	600	300
4395/00/12	12mm	35mm	860	430
4395/00/14	14mm	50mm	1500	750
4395/00/16	16mm	63mm	1810	905



Rigging & Sail Handling



Snubbing Winch

Part No.	Base Dia	Height
4460/00/75	3" 75mm	2 3/4" 70mm



Cam Cleat

Part No.	Rope Dia	Base Size
4450/00/10	8-10mm	76 x 35mm
4450/00/14	12-14mm	105 x 45mm



Cam Cleat with Lead

Part No.	Rope Dia	Base Size
4455/00/10	8 - 10mm	80 x 45mm



Flag Line Block

Part No.	Rope Dia	Sheave Dia
4611/00/8	5mm	20mm



Single Wire Rope Block

Part No.	Wire Dia	Sheave Dia	Breaking Load daN	s.w.l. daN
4405/00/04	4mm	60mm	1130	565
4405/00/05	5mm	75mm	1200	600
4405/00/06	6mm	90mm	2040	1020
4405/00/08	8mm	100mm	2010	1005

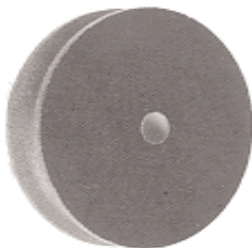

Rope Sheave

Part No.	Rope Dia	Sheave Dia	Sheave Width	Bore
4470/00/25	10mm	25mm	11mm	6mm
4470/00/30	10mm	30mm	11mm	6mm
4470/00/35	10mm	35mm	11mm	6mm
4470/00/40	10mm	40mm	11mm	6mm
4470/00/50	12mm	50mm	13mm	8mm
4470/00/60	12mm	60mm	13mm	8mm
4470/00/70	14mm	70mm	16mm	10mm
4470/00/80	14mm	80mm	16mm	10mm
4470/00/90	16mm	90mm	18mm	10mm
4470/00/100	16mm	100mm	18mm	10mm



Wire Rope Sheave

Part No.	Wire Dia	Sheave Dia	Sheave Width	Bore
4475/00/25	4mm	25mm	9mm	6mm
4475/00/30	4mm	30mm	9mm	6mm
4475/00/35	4mm	35mm	9mm	6mm
4475/00/40	4mm	40mm	9mm	6mm
4475/00/50	5mm	50mm	11mm	8mm
4475/00/60	5mm	60mm	11mm	8mm
4475/00/70	6.5mm	70mm	13mm	10mm
4475/00/80	6.5mm	80mm	13mm	10mm
4475/00/90	8mm	90mm	15mm	10mm
4475/00/100	8mm	100mm	15mm	10mm



ALL NEW

Large Tufnol Type Blocks

Manufactured to the same high standard as the smaller range, these extremely strong blocks are suitable for ropes sizes 13mm to 22mm. They are internally bound with stainless steel and come in four configurations to suit most applications. Approved by Germanischer Lloyd in Hamburg.



Single with Bow	SWL daN	Single with Swivel	SWL daN	Rope Diameter	Sheave Diameter
4410/OO/13	905	-		13mm	75mm
4410/OO/16	2075	4430/OO/16	1845	16mm	90mm
4410/OO/20	2260	4430/OO/20	2435	20mm	100mm
4410/OO/22	3155	4430/OO/22	3290	22mm	120mm



Single with Bow & Becket	SWL daN	Single with Swivel & Becket	SWL daN	Rope Diameter	Sheave Diameter
4415/OO/13	980	-		13mm	75mm
4415/OO/16	2105	4435/OO/16	1850	16mm	90mm
4415/OO/20	2340	4435/OO/20	2415	20mm	100mm
4415/OO/22	3210	4435/OO/22	3290	22mm	120mm



Double with Bow	SWL daN	Double with Swivel	SWL daN	Rope Diameter	Sheave Diameter
4420/OO/13	1100	-		13mm	75mm
4420/OO/16	2400	4440/OO/16	2105	16mm	90mm
4420/OO/20	2585	4440/OO/20	2555	20mm	100mm
4420/OO/22	3155	4440/OO/22	3300	22mm	120mm



Double with Bow & Becket	SWL daN	Double with Swivel & Becket	SWL daN	Rope Diameter	Sheave Diameter
4425/OO/13	1005	-		13mm	75mm
4425/OO/16	2400	4445/OO/16	2105	16mm	90mm
4425/OO/20	2600	4445/OO/20	2555	20mm	100mm
4425/OO/22	3210	4445/OO/22	3265	22mm	120mm

We are also able to supply triple blocks with various types of head and a range of high strength blocks in 316 stainless steel and black nylon with SWL up to 3.5 tonnes.



ALL NEW

Large Tufnol Type Blocks

Manufactured to the same high standard as the smaller range, these extremely strong blocks are suitable for ropes sizes 13mm to 22mm. They are internally bound with stainless steel and come in four configurations to suit most applications. Approved by Germanischer Lloyd in Hamburg.



Single with Bow	SWL daN	Single with Swivel	SWL daN	Rope Diameter	Sheave Diameter
4410/OO/13	905	-		13mm	75mm
4410/OO/16	2075	4430/OO/16	1845	16mm	90mm
4410/OO/20	2260	4430/OO/20	2435	20mm	100mm
4410/OO/22	3155	4430/OO/22	3290	22mm	120mm



Single with Bow & Becket	SWL daN	Single with Swivel & Becket	SWL daN	Rope Diameter	Sheave Diameter
4415/OO/13	980	-		13mm	75mm
4415/OO/16	2105	4435/OO/16	1850	16mm	90mm
4415/OO/20	2340	4435/OO/20	2415	20mm	100mm
4415/OO/22	3210	4435/OO/22	3290	22mm	120mm



Double with Bow	SWL daN	Double with Swivel	SWL daN	Rope Diameter	Sheave Diameter
4420/OO/13	1100	-		13mm	75mm
4420/OO/16	2400	4440/OO/16	2105	16mm	90mm
4420/OO/20	2585	4440/OO/20	2555	20mm	100mm
4420/OO/22	3155	4440/OO/22	3300	22mm	120mm



Double with Bow & Becket	SWL daN	Double with Swivel & Becket	SWL daN	Rope Diameter	Sheave Diameter
4425/OO/13	1005	-		13mm	75mm
4425/OO/16	2400	4445/OO/16	2105	16mm	90mm
4425/OO/20	2600	4445/OO/20	2555	20mm	100mm
4425/OO/22	3210	4445/OO/22	3265	22mm	120mm

We are also able to supply triple blocks with various types of head and a range of high strength blocks in 316 stainless steel and black nylon with SWL up to 3.5 tonnes.